

F-Wave™ RE VIA™ Designer Slate: American Blends Synthetic Roofing Shingles

INSTALLATION MANUAL FOR STEEP-SLOPE RESIDENTIAL INSTALLATIONS

For support with all other Steep-Slope Installations, please call F-Wave Technical Support at 888-GO-FWAVE. To obtain a Spanish version of this Installation Manual for Steep-Slope Residential Installations, please visit fwaverroofing.com or call F-Wave Technical Support at 888-GO-FWAVE.

Para obtener una versión en Español de este Manual Para Instalaciones Residenciales De Pendiente Pronunciada por favor visite fwaverroofing.com o llame al soporte técnico de F-Wave en el 888-463-9283.

PURPOSE OF THESE INSTRUCTIONS

The installation instructions are meant to be a general guide for experienced roofing installation professionals to use when installing F-Wave™ RE VIA™ Roofing Shingles. Our shingles are produced using advanced manufacturing techniques and materials, thus giving them many advantages over traditional asphalt roofing shingles. However, as a primary benefit, the installation methods for F-Wave RE VIA Roofing Shingles are nearly identical to that of traditional asphalt roofing shingles.

The information presented here addresses the particular application of specific general roofing practices to F-Wave RE VIA Roofing Shingles. However, this manual and instructions do not cover every general roofing practice or every detail that an installer may encounter on a shingle installation. In the event that the installation of F-Wave RE VIA Roofing Shingles presents a question not answered in this manual, please call Technical Support at 888-463-9283.

Before installation, the installer must ensure adherence to all applicable state and local building codes.

SAFETY

- ALL ROOFING AND RELATED ACTIVITIES SHOULD ALWAYS BE COMPLETED WITH SAFETY IN MIND.
- ALL GOOD AND PROVEN SAFETY PRACTICES SHOULD BE FOLLOWED.
- FALL PROTECTION EQUIPMENT MAY BE REQUIRED AND IS ALWAYS ADVISABLE.
- ROOFING ACTIVITY CAN BE DANGEROUS. ALL NECESSARY PRECAUTIONS AND SAFETY GUIDELINES MUST BE FOLLOWED IN ACCORDANCE WITH PROPER ROOFING TRADE PRACTICES AND REGULATIONS, OSHA REQUIREMENTS AND LOCAL BUILDING CODES.

NOTE: F-Wave shingles are a semi-rigid roofing shingle and must be installed according to F-Wave application instructions and requirements by a roofing professional. F-Wave assumes no responsibility for leaks and other defects that result from failure to properly prepare the surface to which the shingles are applied or from improper and poor application – this includes a properly attached and smooth wood deck, the required use of a synthetic roofing underlayment, the required use of only approved sealants or adhesives, and a requirement for the installer to provide proper attic ventilation in accordance with the standard minimum requirements. The installer is responsible for reviewing all applicable building codes, property standards, and requirements for the shingles to be installed before using the application instructions printed on the inside of each RE VIA Shingle wrapper or at fwaverroofing.com.

General Installation

When installing F-Wave RE VIA Roofing Shingles, always consult your local building codes, regulations and minimum property standards to ensure adherence to all applicable requirements. For additional installation information, please visit us online at fwaverroofing.com/resources or call F-Wave Technical Support at 888-GO-FWAVE.

INSTALLATION OF F-WAVE RE VIA SYNTHETIC ROOFING SHINGLES

Any significant differences between the installation of traditional asphalt shingles and F-Wave RE VIA Roofing Shingles are set forth in this manual. Generally, the installation methods are similar, but care should be taken by the installer to read and understand each section of this manual prior to installation.

ROOF DECK

The selection and installation of the roof deck should always be done after consulting and adhering to local building codes, minimum property standards, and manufacturer’s recommendations. F-Wave recommends using well-seasoned plywood with a minimum thickness of 15/32 inch (12mm) or OSB decking with a minimum thickness of 7/16 inch (11mm) that is well supported. Always ensure the roof deck is properly attached and provides a smooth, flat surface on which to install our shingles. Additionally, we recommend thoroughly checking that both the deck and other roofing materials are dry before installing the shingles.

UNDERLAYMENT

F-Wave requires the use of synthetic underlayment that complies with ASTM D226, Type I or Type II; ASTM D4869, Type I or II; or ASTM D6757. In addition, F-Wave requires the use of self-adhering waterproofing underlayment (compliant to ASTM D1970) for critical areas, such as valleys and eaves. F-Wave also recommends the use of a smooth-surface, non-granulated, self-adhering waterproofing underlayment on other flashings such as ridges, hips, pipe penetrations, dormers, slope changes, skylights, and chimneys. F-Wave does not approve of the use of any radiant barrier type products as a shingle underlayment installed above the deck when used with F-Wave REVIA Roofing Shingles. Underlayment must be applied flat and unwrinkled to the roof deck and the selection as well as the installation of underlayment should always be done after consulting and adhering to local building codes. The underlayment and installation method used must comply with or exceed local building codes, the published installation requirements of the underlayment manufacturer, and F-Wave requirements. After the application of the underlayment, our shingles should be installed as soon as possible.

RE-ROOFING OVER EXISTING ASPHALT SHINGLES & OTHER ROOFING MATERIALS IS NOT ALLOWED

The F-Wave WeatherForce™ Advantage Standard Product Limited Warranty requires installation over a clean roof deck covered with a synthetic underlayment that complies with ASTM D226, Type I or Type II; ASTM D4869, Type I or II; or ASTM D6757.

OTHER RE-ROOFING CONSIDERATIONS

Check with local building codes to determine whether or not any pre-inspections or approvals are required, and to determine any specific standards that must be followed as defined by the relevant building codes and minimum property standards. Existing structure and deck must be suitable for safe working conditions and the addition of the new shingles. It is also advisable to check that existing ventilation is adequate and ensure that the attic ventilation will meet the minimum standard as defined by the relevant building codes and minimum property standards.

ICE DAM PROTECTION

In climates that have the potential for snow and ice there is always a possibility for the formation of ice dams at the eaves and any other uninsulated or unheated overhangs. In such climates, F-Wave requires that a smooth-surface, non-granulated, self-adhering waterproofing membrane be applied at the eaves and extend a minimum of 24 inches (610mm) up the roof deck from the location of the interior side of exterior walls. Please note: The requirements for smooth-surface, non-granulated, self-adhering waterproofing membrane must comply with or exceed local building codes and F-Wave requirements.

USE OF DRIP EDGE AT ROOF EAVES & RAKES

The selection and installation of the drip edge metal should always be done after consulting and adhering to local building codes and minimum property standards. At the eave, F-Wave recommends the use of a D-style drip edge made of corrosion-resistant materials that extends a minimum of 2 inches (51mm) back from the roof edge and bends downward over the fascia. At the rake edge, F-Wave recommends the use of a T-Style modified drip edge as seen in **Figure 1** to cover the cut edge of the REVIA shingles.

When applying T-Style modified drip edge at the rake edge, all underlayment should be installed under the drip edge metal and shingles should be trimmed flush with the drip edge. When applying drip edge at the eaves, all underlayment should be installed over the drip edge metal and shingles should be trimmed flush with the drip edge or with an overhang of 3/4 inch (19mm) or less.

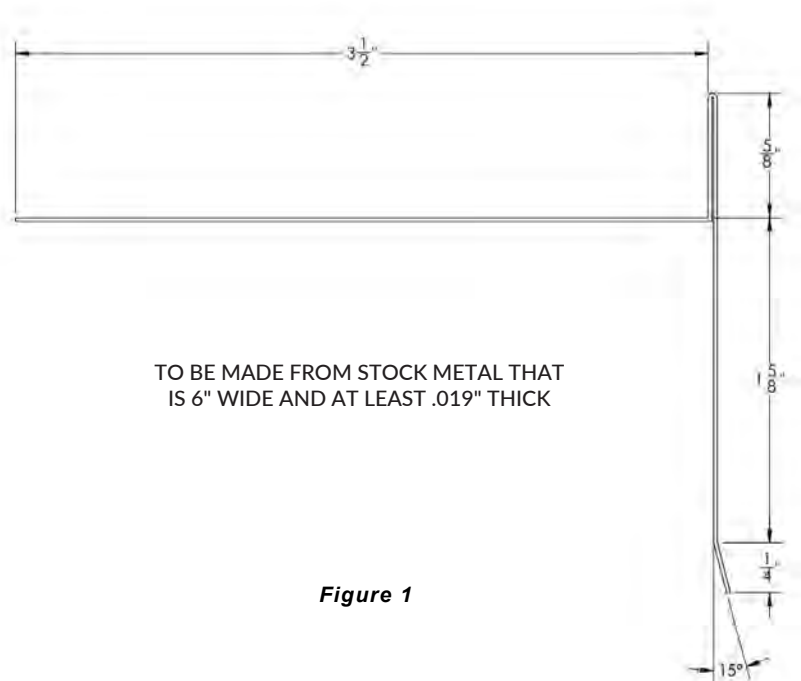

Figure 1

ROOFSLOPES

Standard installation slopes are defined as greater than 4:12 slope, which is 4 inches (102mm) vertical rise per 12 inches (305mm) horizontal run, and less than 21:12 slope, which is 21 inches (533mm) vertical rise per 12 inches (305mm) horizontal run. Low slopes are defined as greater than 2:12 slope, which is 2 inches (51mm) vertical rise per 12 inches (305mm) horizontal run, and less than 4:12 slope. Steep slopes are defined as slopes greater than 21:12 and are also covered in the following sections.

LOW-SLOPE INSTALLATION

For low slope applications, defined as slopes between 2:12 and 4:12, F-Wave REVIA shingles become ornamental and the underlayment installed becomes the primary water barrier. F-Wave therefore requires the use of one layer of self-adhering waterproofing underlayment be installed or two layers of synthetic underlayment be installed for the entire low slope surface. Installations on slopes below 2:12 are not allowed.

RECOMMENDED FASTENING

The selection and use of fasteners should always be done after consulting and adhering to both local building codes and F-Wave's requirements. F-Wave requires the use of 11 or 12 gauge roofing nails that are corrosion-resistant and with heads that are a minimum of 3/8 inch (9.5mm) in diameter and a minimum of 1 1/4 inches (32mm) long. Ring-shank nails are recommended. In all roofing applications, F-Wave requires that the nails be long enough to penetrate 3/4 inch (19mm) into the roof deck. Where the roof deck is less than 3/4 inch (19mm) thick, the nails should be long enough to penetrate the deck fully and extend at least 1/8 inch (3.2mm) through the roof deck. Please note: Staples are not an approved fastening method. When fastening, all nails must be driven straight and with the heads flush to the shingle surface, never cutting into the shingle as detailed in **Figure 2**. Fasteners must not be exposed or visible on the finished roof.

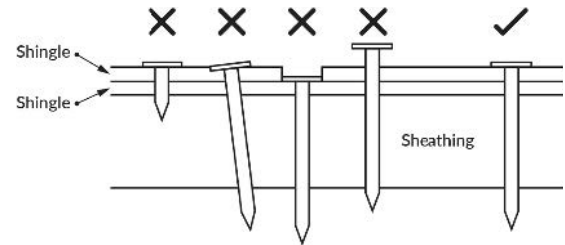

Figure 2

FASTENER LOCATIONS

Use six fasteners per shingle in all applications including high-wind or steep-slope applications. The fasteners must be located 1 inch (25mm) from the top of the exposure on the F-Wave REVIA Roofing Shingle wide nailing zone and 1 inch (25mm), 7 inches (178mm), and 15 inches (380mm) from either side of the shingle. The fasteners should never be exposed once the installation is complete. See **Figure 3**.

SEALING

Shingle sealing may be delayed when shingles are applied in cool weather. Therefore, it is required that REVIA shingles be installed at temperatures of 50 F (10 C) and rising with a rooftop surface temperature exceeding 74 F (23 C). If shingles have not sealed after a reasonable amount of time it may be necessary to hand-seal any unsealed shingles. See the section below covering Steep Slopes and High-Wind Installations for information on hand sealing.

STEEP SLOPES&BUILDING CODE-REQUIRED HIGH-WIND INSTALLATIONS

For roof slopes greater than 21:12 and for High Wind installations, 6 fasteners per shingle must be used. The fasteners must be located 1 inch (25mm) from the top of the exposure on the F-Wave REVIA Roofing Shingle wide nailing zone and 1 inch (25mm), 7 inches (178mm) and 15 inches (380mm) from either side of the shingle.

At the start of the slope and for the entire slope, apply five 1 inch (25mm) diameter sized spots of F-Wave approved sealant and adhesive (see **Table 1** below). One spot behind every tab (Total of 5 spots) and near the bottom, the shingle is then pressed down into position. See **Figure 3**. F-Wave approved sealant and adhesive should come near the edge of the shingle, but not be exposed. Failure to seal due to installation temperatures being below sealant manufacturer's minimum acceptable installation temperature is not a manufacturing defect and F-Wave accepts no responsibility for any loss whatsoever arising out of or relating to sealant failure due to installation temperatures being below or above the sealant manufacturer's minimum acceptable installation temperature. F-Wave defines high winds as 131mph or higher as determined by the relevant building codes and minimum property standards in certain geographic areas. Application of additional sealant is not required for high wind installs unless required by local building codes. Please consult your local building codes and property standards for clarification.

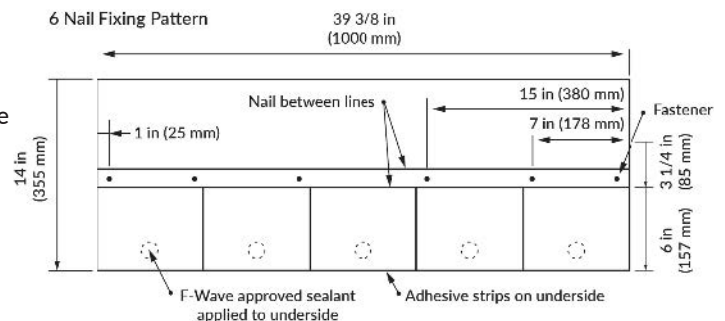

Figure 3

TABLE 1 – APPROVED SEALANTS & ADHESIVES

Manufacturer	Product Name
NPC Sealants	#900 Solar Seal
R.M. Lucas Co.	#6600 Universal Terpolymer Sealant
OSI	Quad® Sealant
Mulehide	SEBS1 Approved, (JTS1 NOT Approved)

NOTE: Do not use asphalt-based underlaments, adhesives or sealants. These products are not compatible with F-Wave REVIA Synthetic Shingles and will void the WeatherForce Advantage Limited Product Warranty. Only use F-Wave approved sealants and adhesives as outlined in these installation instructions.

ATTIC VENTILATION

Improper attic ventilation can cause moisture buildup in the attic, heat stress on the roofing materials, and ice damming - all situations that can lead to the premature failure of roofing materials such as the wood decking. Therefore, please consult your local building codes for requirements regarding attic ventilation. To ensure proper attic ventilation, air must be allowed to circulate freely from the attic eaves to the attic peaks. F-Wave requires that attic ventilation meet or exceed the minimum standard as defined by the relevant building codes and minimum property standards. As an alternative to standard attic ventilation, F-Wave does allow for a unvented conditioned attic space utilizing spray foam insulation methods.

ROOF PENETRATIONS

All roof penetrations should be properly flashed using standard roofing practices. For further details, please refer to fwaverroofing.com.

Shingle Installation

APPLICATION PATTERN

F-Wave REVIA Roofing Shingles must be installed in 1 1/2 tab offsets in a diagonal application pattern. It is important to follow the installation method as described and shown in **Figure 5**, **Figure 6** and **Figure 7** to ensure the integrity of the roof. F-Wave is not responsible for the integrity of the roof if these installation methods are not followed.

STARTER COURSE

- F-Wave requires the use of an F-Wave REVIA Starter Shingle to ensure proper waterproofing and aesthetics. Only F-Wave REVIA Starter Shingles are designed specifically to work with F-Wave REVIA Roofing Shingles. Cut 6 1/2 inches (165mm) off the length of the first starter strip installed on the roof. The starter course should overhang the eaves by 1/4 to 3/8 inch (6 to 10mm).
- Continue applying the starter shingles across the roof eave. Install with six fasteners 1 inch (25mm) up from the eave edge, one fastener 1 inch (25mm) from each side of the starter with the remaining two evenly spaced on the same line as the end fasteners.

FIRST COURSE

- Apply a full shingle flush with the starter course at the lower left-hand corner of the roof and secure with fasteners. Please note: Shingles can be installed from the right-hand corner as long as the same offset patterns are used. Apply full shingles for the remaining first course.

SECOND COURSE

- Cut 1 1/2 tab from the left end of the shingle and apply the remaining shingle section over the first course shingle, exposing the first course 6 inches (152mm) from the bottom. Apply full shingles for the remaining second course.

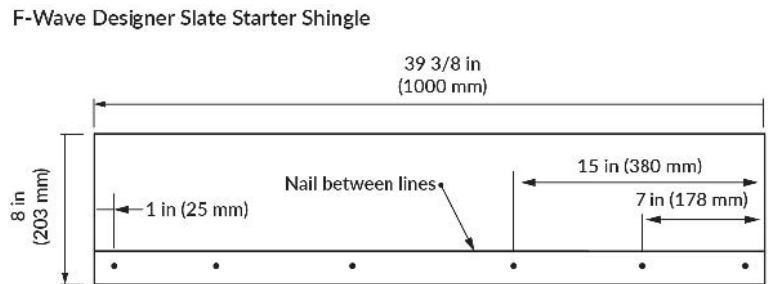
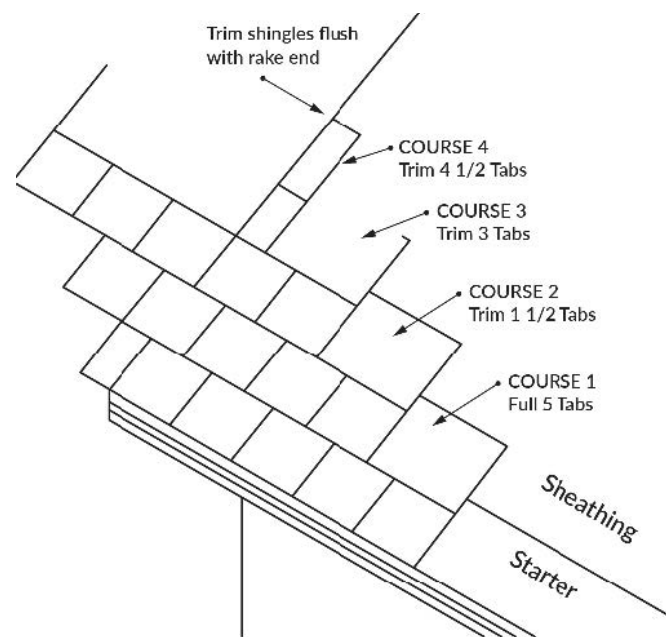
Figure 4

Figure 5

THIRD COURSE

- Cut three tabs off the left end of the shingle and apply the remaining shingle section over the second course shingle, exposing the second course 6 inches (152mm). Secure with fasteners. Apply full shingles for the remaining third course.

SUCCEEDING COURSES

- Courses 2 through 6 begin with a partial shingle progressively 6 1/2 inches (165mm) shorter, establishing the overall diagonal method or stair-step effect.
 - Course 1 = Full shingle, 39 3/8 inches (1000mm).
 - Course 2 = Trim 1 1/2 tabs off the left side. Shingle will be 27 1/5 inches (700mm) long.
 - Course 3 = Trim 3 tabs off the left side. Shingle will be 15 3/4 inches (400mm) long.
 - Course 4 = Trim 4 1/2 tabs off the left side. Shingle will be 4 inches (100mm). Note, This 1/2 tab piece can be cut from the leftover from course 2.
 - Course 5 = Full Shingle. Repeat Pattern.
- Pieces cut from shingles along the left rake can be used elsewhere in the roof where a short piece may be needed.
- Courses 5 through 9: Repeat pattern, beginning with a full shingle and continue succeeding courses with a partial shingle 1 1/2 tabs shorter each time. Succeeding courses repeat this procedure beginning each fifth course set with a full shingle.
- F-Wave suggests that it is good practice to apply a chalk line every 4 to 6 feet up the roof surface to keep the courses straight and the exposures consistent at 6 inches (152mm). Use Blue Chalk only! Red Chalk can leave permanent stains on the roof.

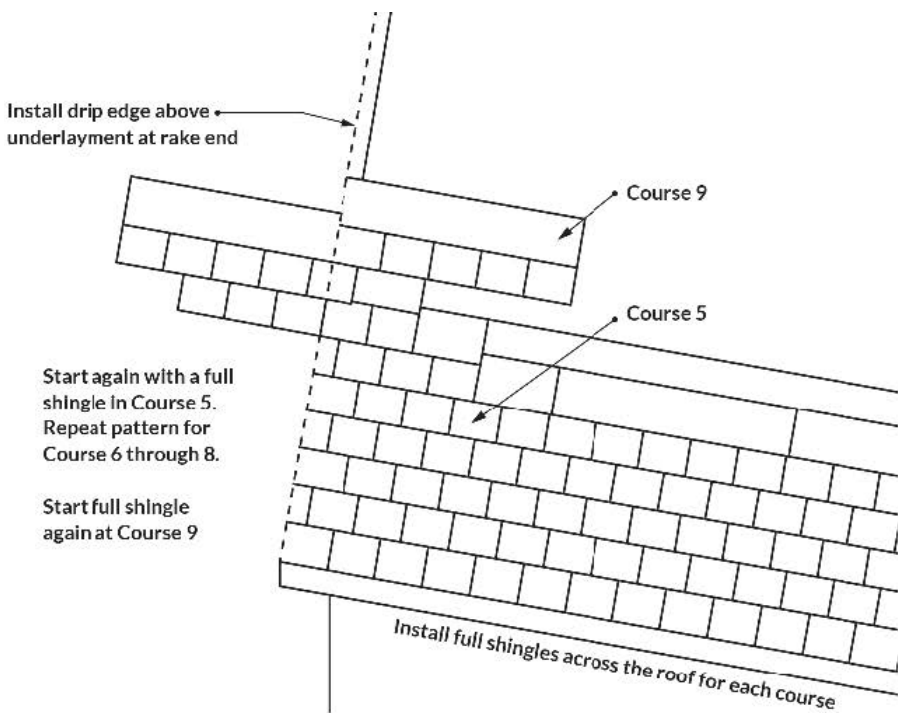

Figure 6

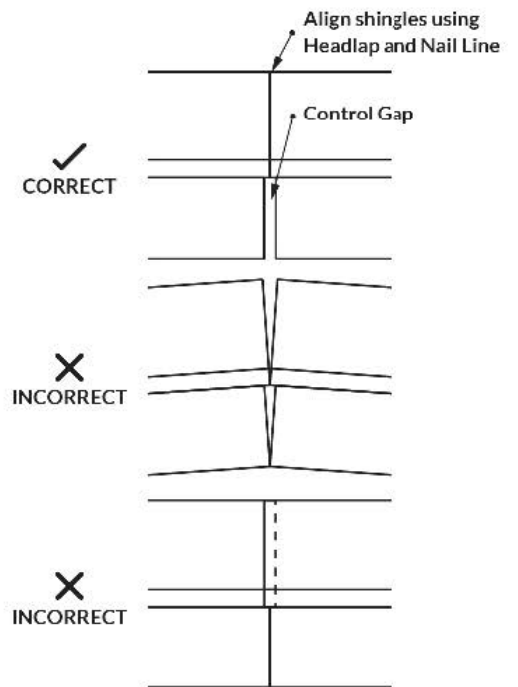

Figure 7

USING THE ALIGNMENT MARKS

Each Designer Slate shingle has alignment marks at the top center of each tab to aid in the straight placement of shingles. Use the alignment mark to place the next shingle course and ensure that the shingle is centered over the tab on the shingle course below and that the correct exposure is used. Align the top of the exposure on the shingle side with the corner of the alignment mark. Then continue with installation.

USING THE ALIGNMENT MARKS

Position each shingle using alignment mark

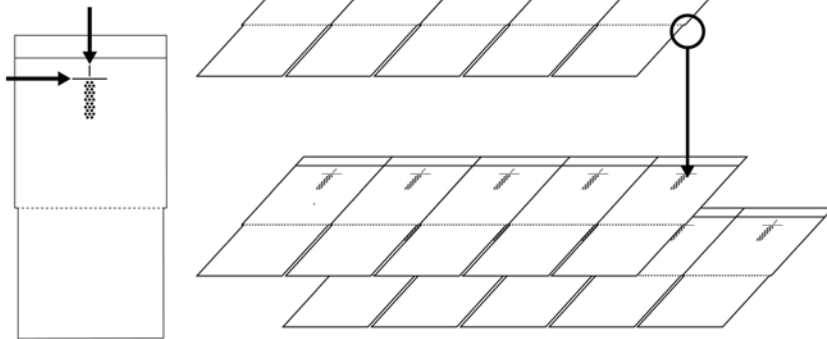

CORRECT
1.5 shingle tab spacing.

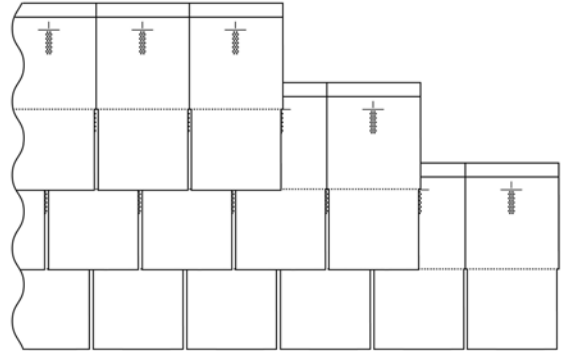

INCORRECT
alignment due to .5 shingle spacing instead of the correct 1.5 shingle spacing.

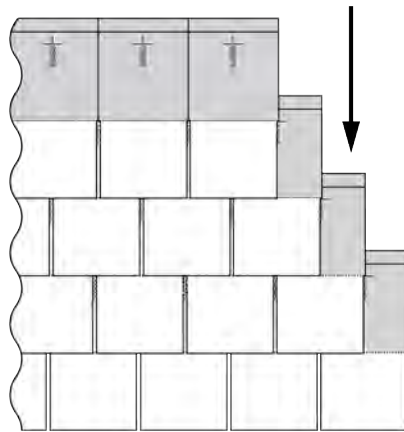

INCORRECT
alignment due to the use of an in-out placement pattern on the edge instead of the cascading pattern and due to the use of .5 tab spacing instead of 1.5.

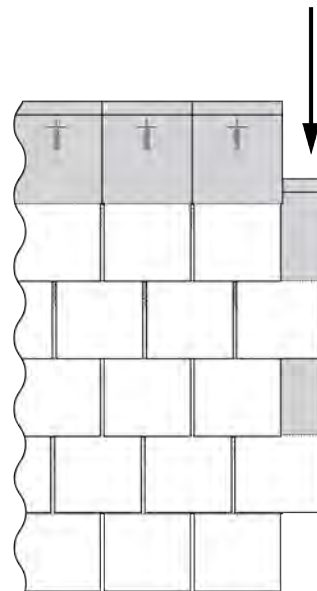

VALLEY

F-Wave recommends the use of an open valley method with a "W" style metal. Alternatively, F-Wave recommends the use of a tile/slate style closed valley method with a "W" style metal. For alternative valley installation methods, please visit fwaverroofing.com and review our latest technical bulletin. It is important to note that all valley flashings should be in place before shingles are installed near the valleys. For application, start with a layer of a minimum of 36 inches (915mm wide smooth-surface, non-granulated, self-adhering waterproofing membrane and apply directly to the roof deck. Next, the valley metal should be installed over self-adhering waterproofing membrane. Cut the top corner of the shingle going into the valley at a 1 inch (25mm) 45° angle. See **Figure 8**.

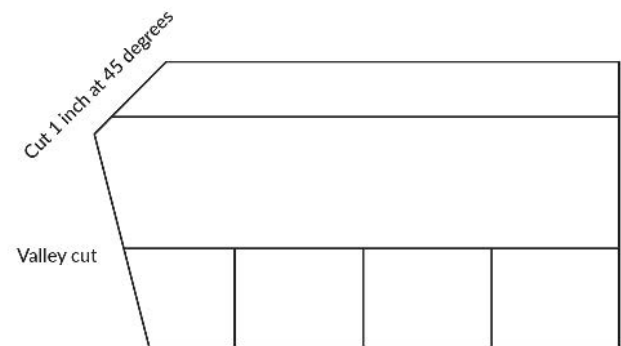

Figure 8

OPEN VALLEY

- Consult local building codes for width of the metal valley and for allowed materials. The width should be a minimum of 12 inches (305mm) on each side. Install the metal valley on top of the underlayment and fasten 1 inch (25mm) from the edges of the valley. When overlapping metal valley pieces, ensure a minimum overlap of 4 inches (102mm) and seal together with an F-Wave approved sealant and adhesive (see **Table 1**). Do not apply fasteners at the overlaps except on the edges.
- Apply a chalk line with blue chalk on either side of the valley. Please refrain from using red chalk as it will stain. Start at 4 inches (102mm) width at the top of the valley and add 1/8 inch (3mm) for every 12 inches (305mm) of length of the valley. This will allow for increased water flow near the eaves of the roof.
- Apply the first course of shingles along the eave until it meets the center of the valley. Trim the valley shingle so that it matches the chalk line and also has a 1 inch (25mm) 45° angle cut from the top of the shingle. See **Figure 8**.
- Apply two parallel 1 inch (25mm) wide beads of F-Wave approved sealant and adhesive (see **Table 1**) to the underside of the cut valley shingle. This will seal the valley shingle to the metal.
- Apply the remaining courses of shingles as was done for the first course. Ensure that the edges of the valley shingles are cut to match the chalk lines. Shingle nail should extend no more than 3 inches from either edge of the valley metal.

ROOFTO WALL FLASHINGS

F-Wave recommends that wherever the roof meets a vertical wall the shingles must be properly flashed with metal under the shingles. In many cases, we also advise the use of a counterflashing over the top of the shingles for added waterproofing. All siding materials should terminate at least 2 inches (51mm) above the roofing surface and overlap the metal flashing by at least 2 inches (51mm). When shingles overlap a metal flashing, do not fasten through the metal. Use F-Wave approved sealant and adhesive (see **Table 1**) to adhere the shingle to the metal.

See **Figure 10**.

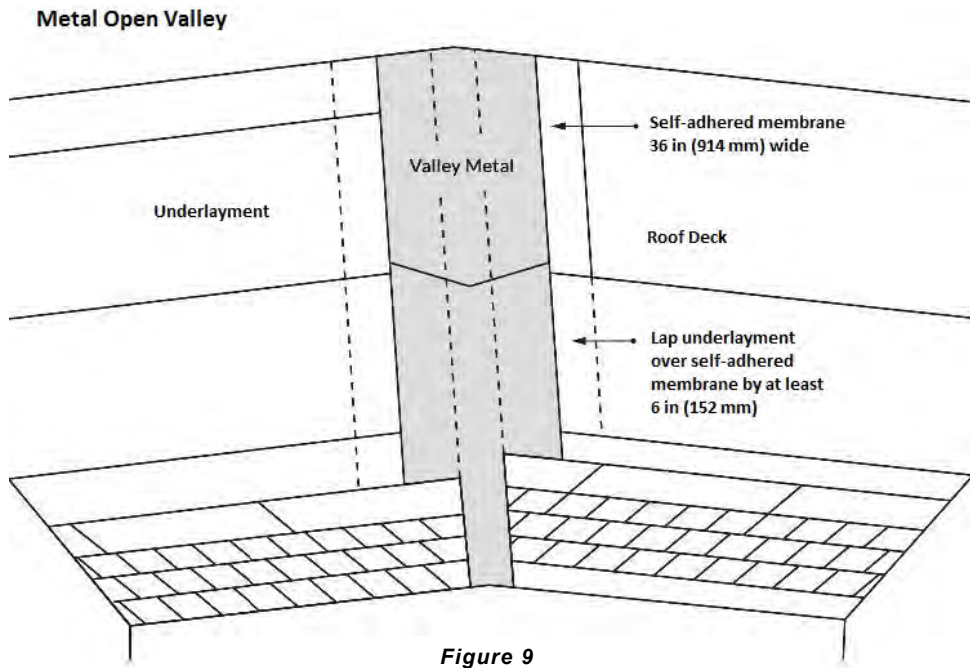

Figure 9

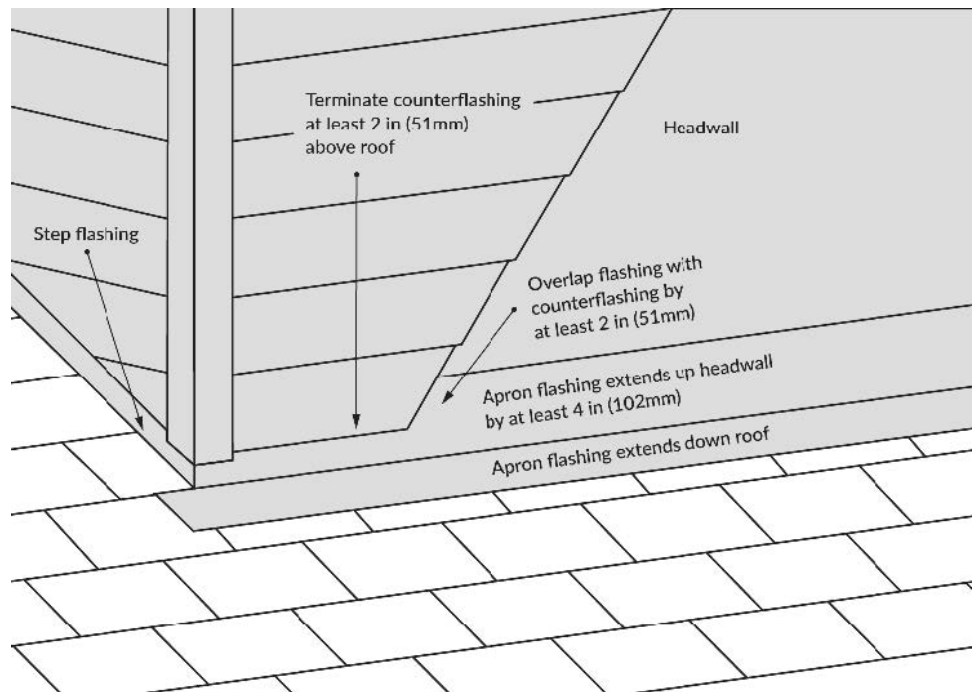

Figure 10

ROOFTO SIDEWALLS

F-Wave recommends the use of a 8 inch x 8 inch (203mm x 203mm) step flashing piece. Interlace step flashing with shingle courses as the shingles are applied. Step flashing must extend at least 4 inches (102mm) up the sidewall and at least 4 inches (102mm) over underlapping shingles. Fasten step flashing to the roof deck only, using two nails installed into the top overlapped region. Overlap pieces of step flashing by 2 inches (51mm.) Use F-Wave approved sealant and adhesive (see **Table 1**) to adhere the underside of the shingle to the metal step flashing.

ROOFTO HEADWALLS

Apply roof shingles up to the edge of the headwall. Install an apron flashing at least 5 inches (127mm) up the headwall and extending at least 4 inches (102mm) down the roof. Nail apron flashing to the roof deck only and seal to shingles with F-Wave approved sealant and adhesive (see **Table 1**). Do not nail the apron flashing to the wall and instead secure with siding material over the top. Apply a second row of shingles over the metal flashing on the roof surface and trim to cover any exposed metal. Use F-Wave approved sealant and adhesive (see **Table 1**) to adhere the cut shingle to the metal apron. See **Figure 11**.

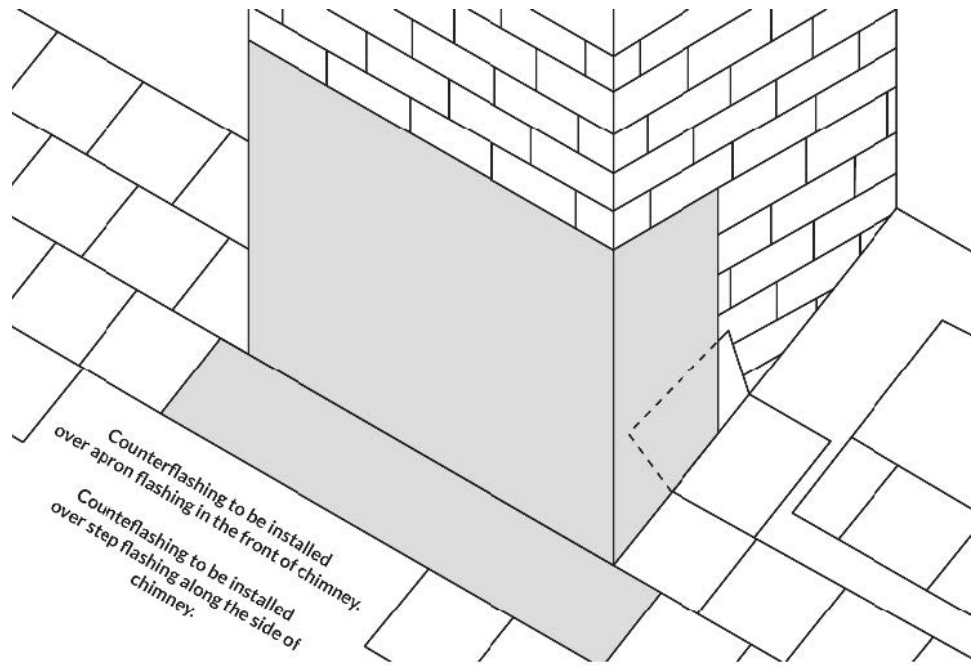

Figure 11

CHIMNEY FLASHINGS

Apply underlayment up to the base of the chimney. Install an apron flashing on the front of the chimney and step flashing along the sides. For more details, see the **Roof to Wall Flashings** section. Install prefabricated metal cricket flashing or field fit using roofing flashing of sufficient width to cover the cricket. The metal flashings of chimneys, skylights, vents and adjoining walls must be counterflashed with sheet metal cap flashing. See **Figure 11**.

Hip & Ridge Product Installation

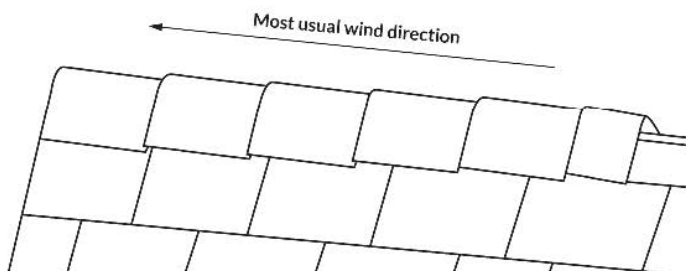

Figure 12

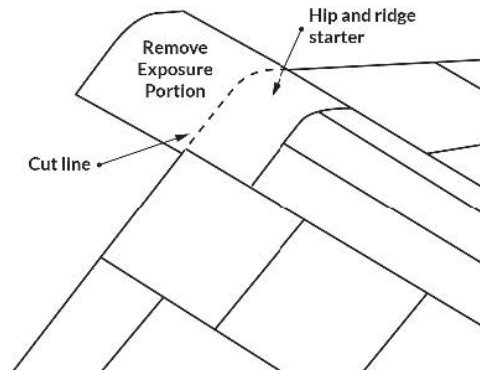

Figure 13

HIPS & RIDGES

Install F-Wave REVIA Hip and Ridge Shingles along the hips and ridges. Only F-Wave REVIA Hip and Ridge Shingles are designed specifically to work with F-Wave REVIA Roofing Shingles. Attach using two fasteners, a minimum of 1-3/4 inch length, installed 1 inch (25mm) at the "Nail Here" mark from the edge of the shingle and penetrating through or at least 3/4 inch (19mm) into the roof deck or 1/8 inch (3.2mm) through the roof deck. Begin at the bottom of the hip. When installing at the ridge, start the hip and ridge shingles from the opposite direction of the prevailing winds. See **Figures 12 & 13**. For more information on F-Wave Hip and Ridge installation, please review our Technical Bulletin at fwaverroofing.com.